

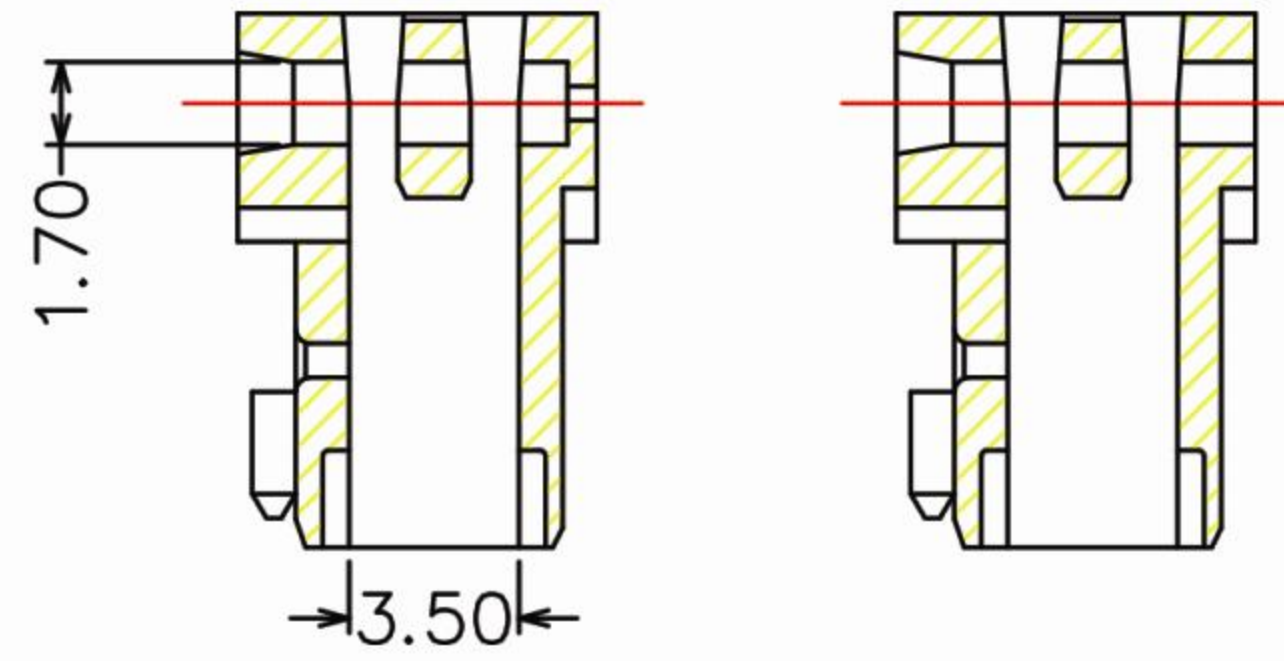

M7243R

M7243

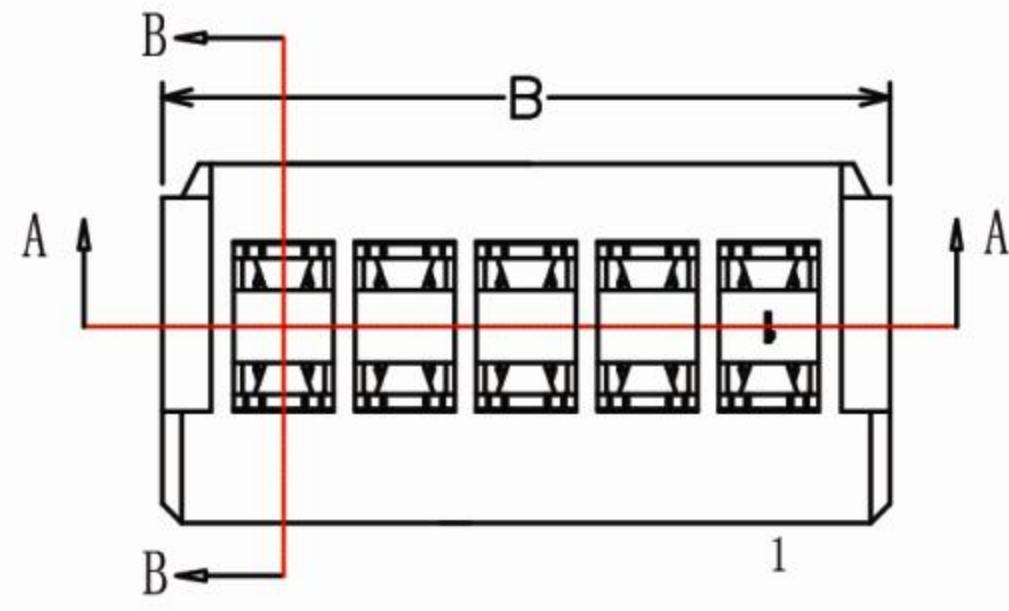

SECTION: B-B

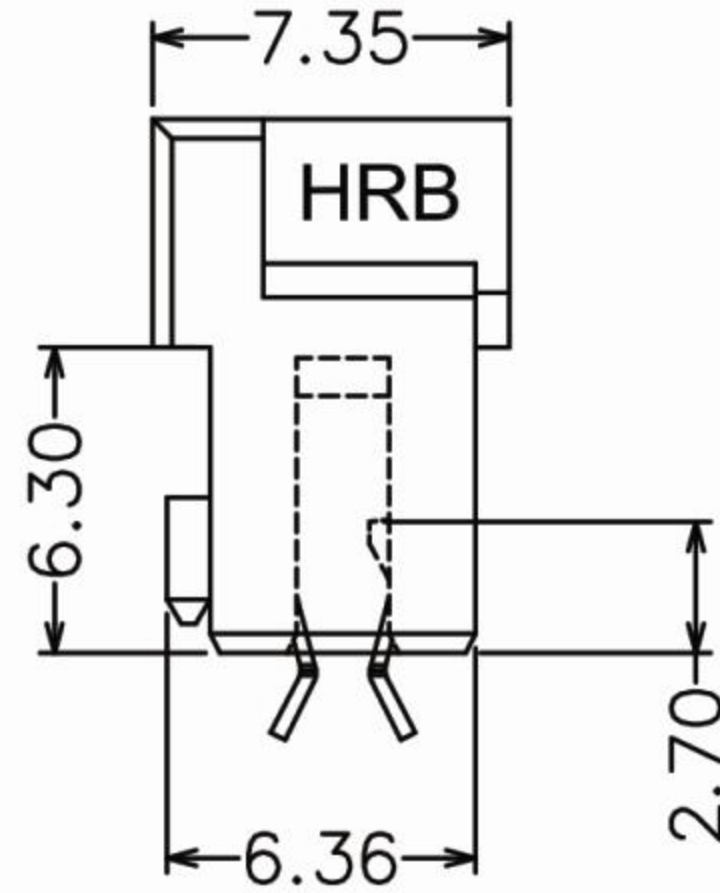
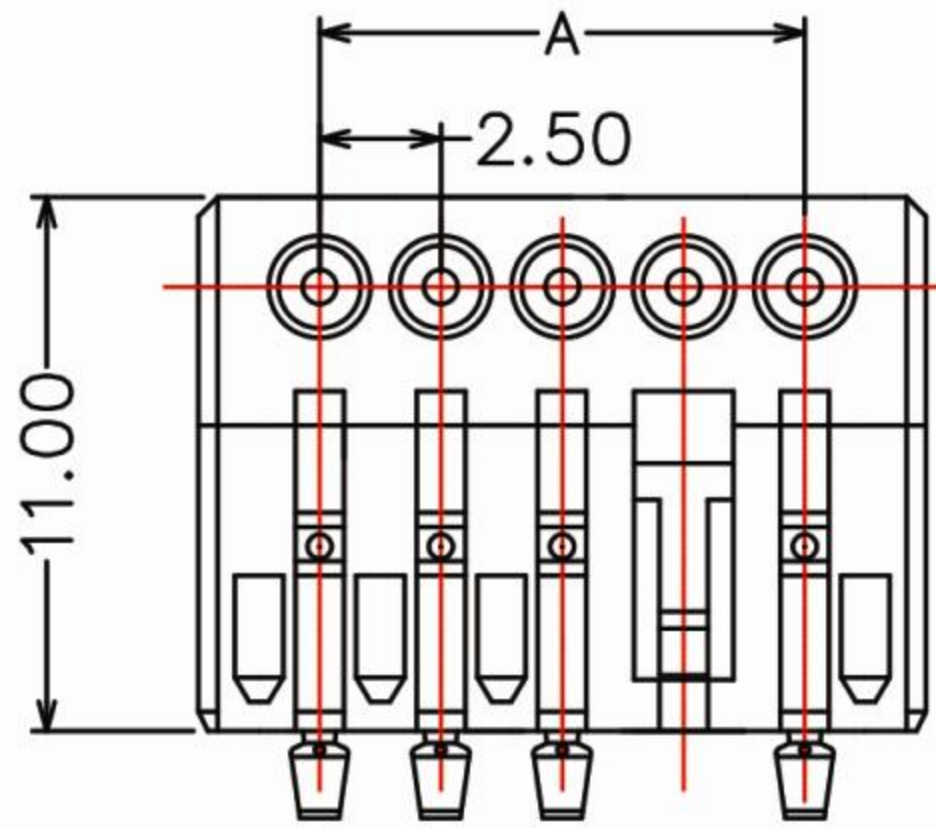

### SPECIFICATION

Current rating: 3A AC, DC  
 Voltage rating: 32V AC, DC  
 Operating Temperature: -40°C--+120°C  
 Contact Resistance: 10mΩ max.  
 Insulation resistance: 1000MΩ min.  
 Withstanding voltage: 1400V AC/minute  
 Material: Housing: Nylon66 UL94V-0  
 Terminal: Phosphor bronze, Tin-plated  
 Wire range: AWG 24 to 22  
 GWT: 750°C IEC-60335-1

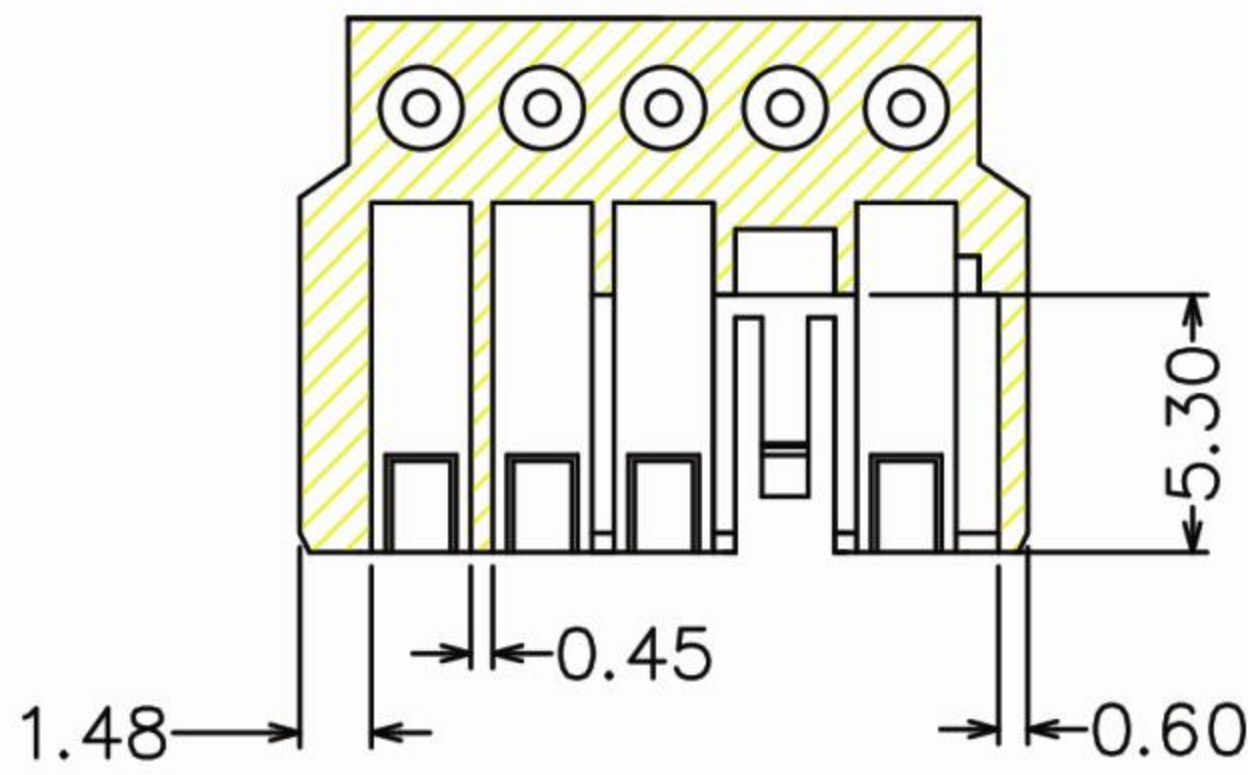

SECTION: A-A

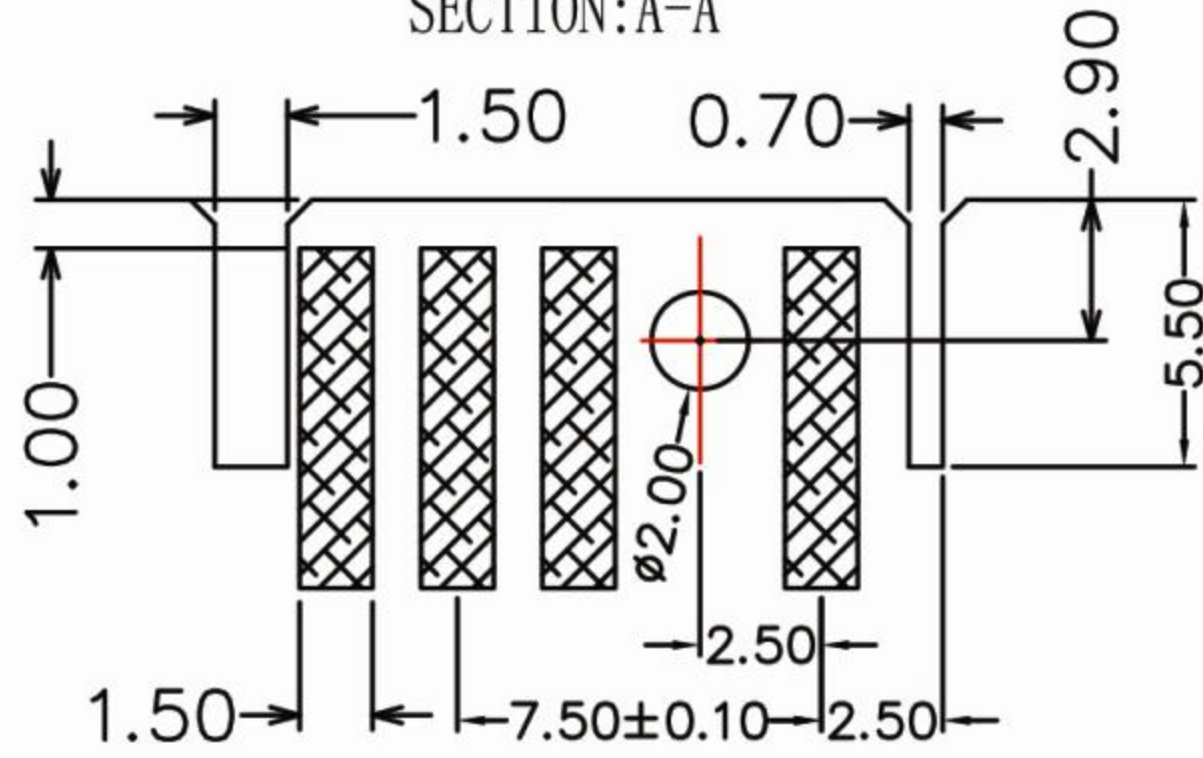

Dimension		
Circuit No.	A	B
2	2.5	7.5
3	5.0	10.0
4	7.5	12.5
5	10.0	15.0
6	12.5	17.5
7	15.0	20.0
8	17.5	22.5
9	20.0	25.0
10	22.5	27.5
11	25.0	30.0
12	27.5	32.5
13	30.0	35.0
14	32.5	37.5
15	35.0	40.0
16	37.5	42.5
17	40.0	45.0
18	42.5	47.5
19	45.0	50.0
20	47.5	52.5

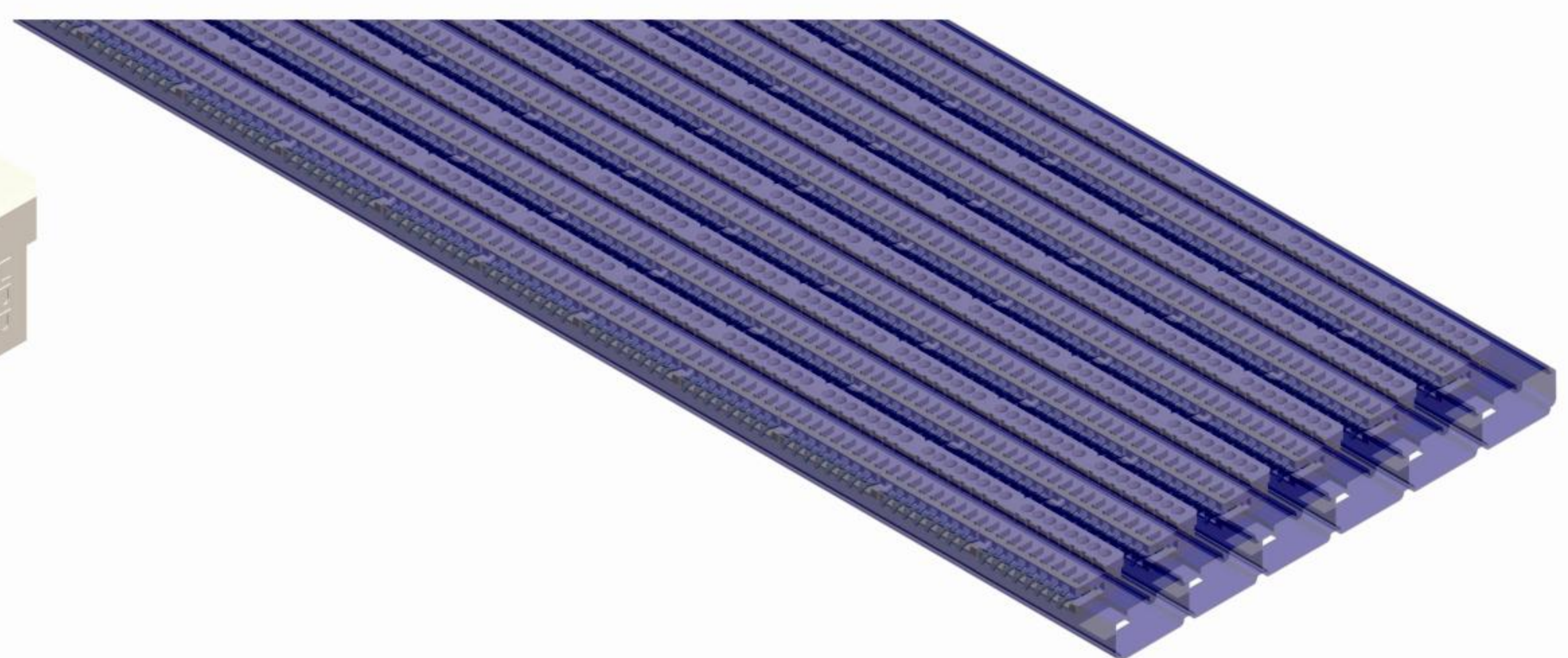
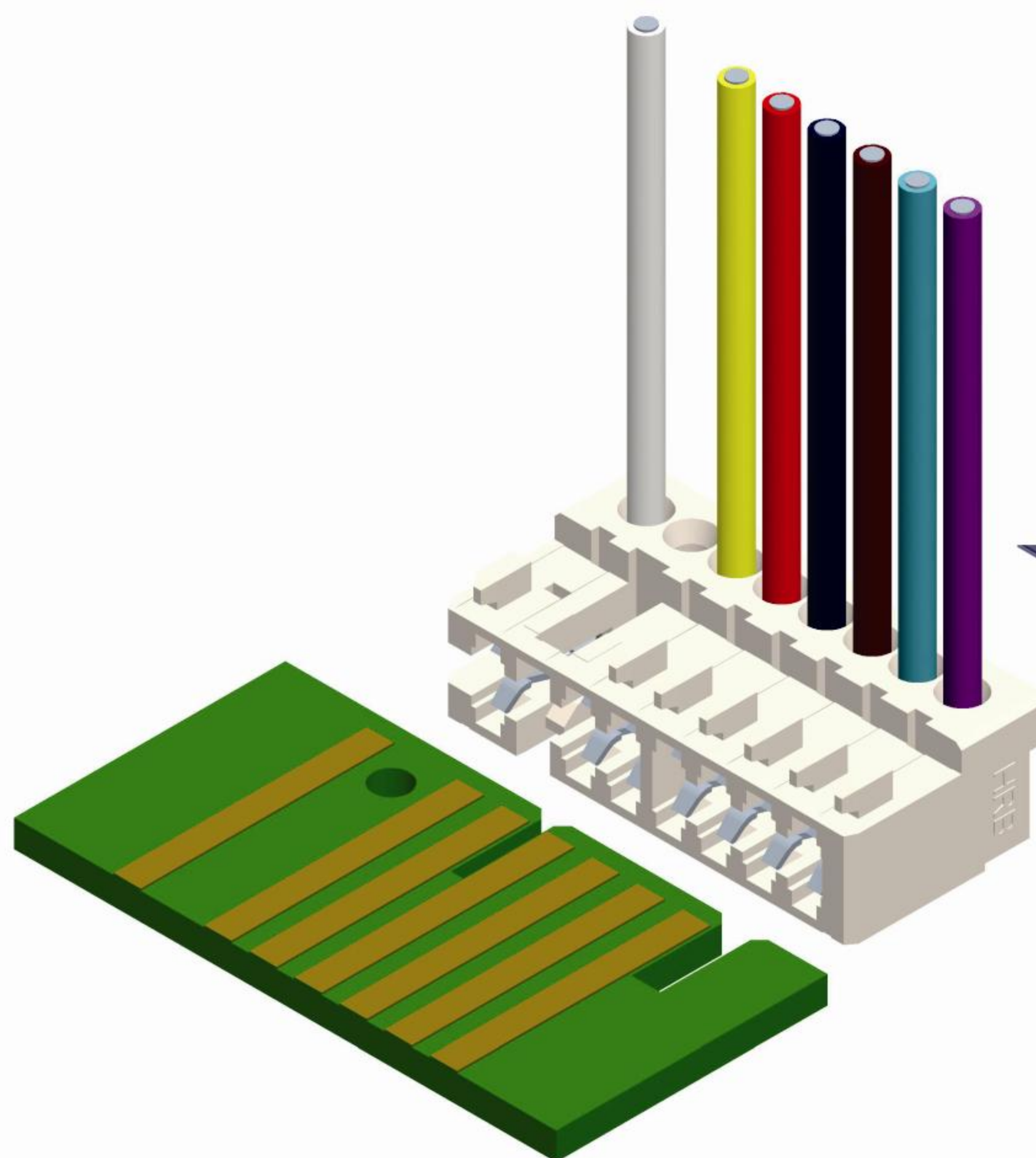



### M7243 Series coding chart

M7243 R-X-X X-X-X-X(X)-VX

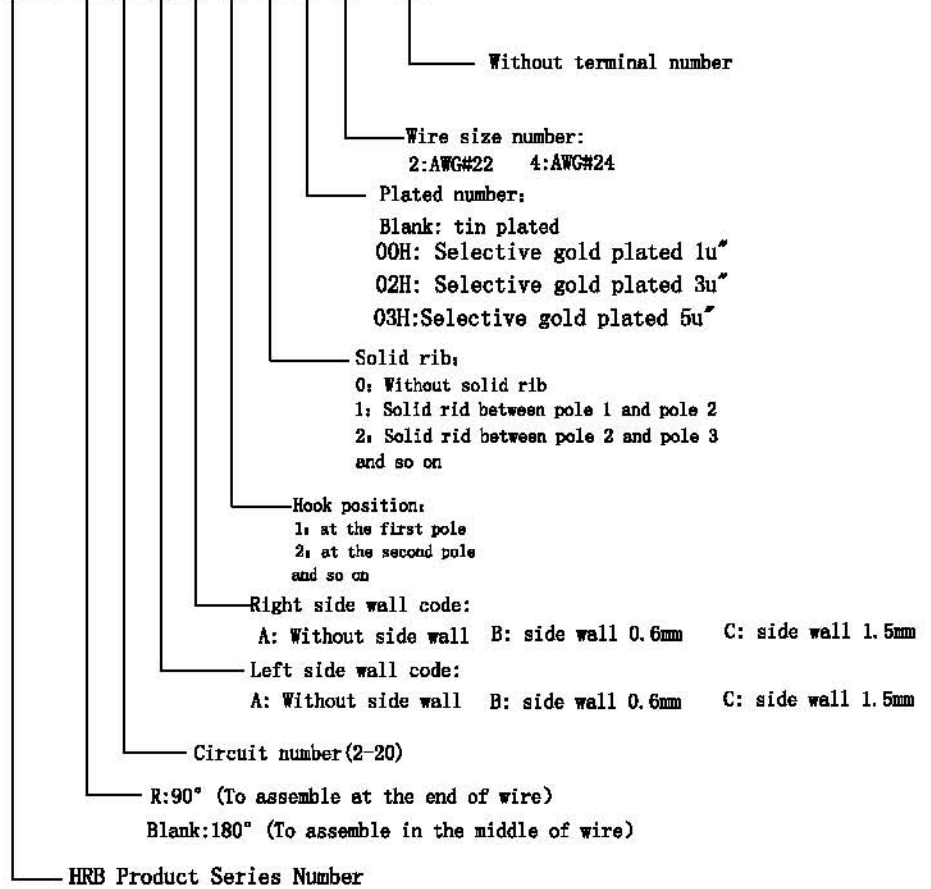

View

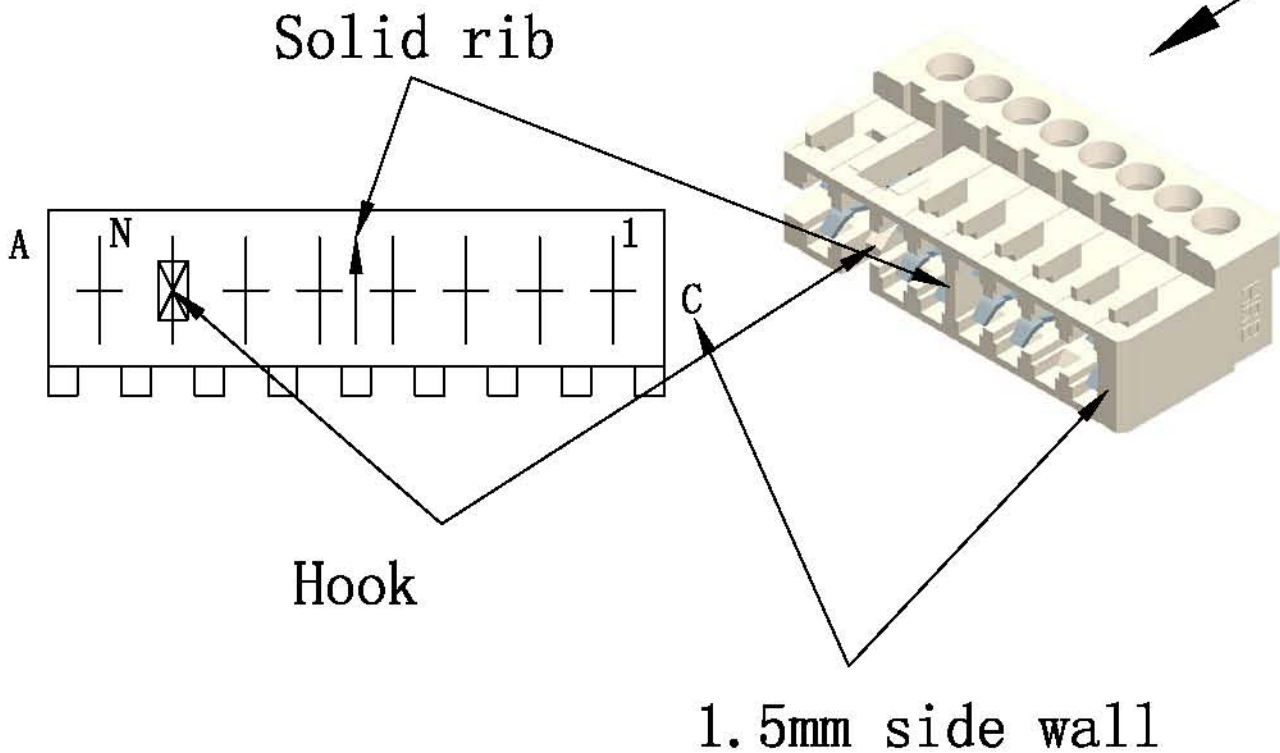

The following part numbers are the ones that have been producing in HRB. Of course, we can adjust the fool-proof positions and circuits of product to define some new part numbers and produce.

You're welcome to choose our product!

## 4 Circuits

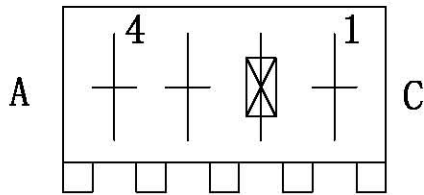

M7243-4-AC-2-0(2)

## 5 Circuits

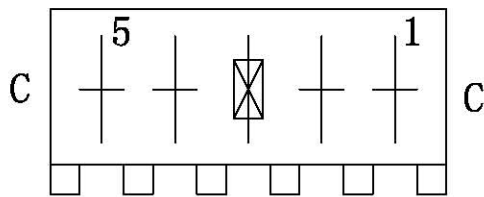

M7243R-5-CC-3-0(4)

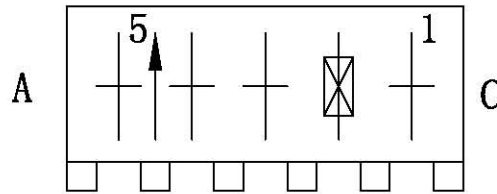

M7243R-5-AC-2-4(2)

## 7 Circuits

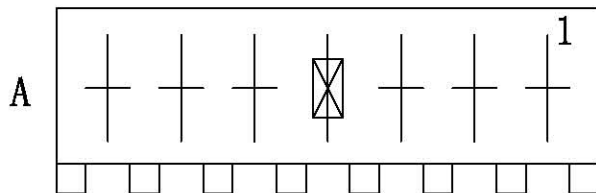

M7243R-7-AB-4-0(4)

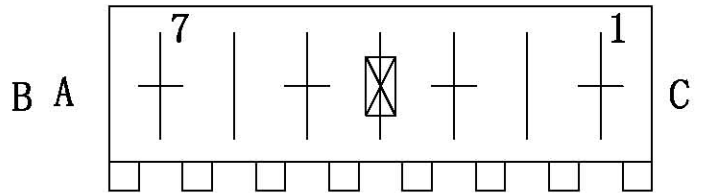

M7243R-7-AC-4-0(2)-V2

# 15 Circuits

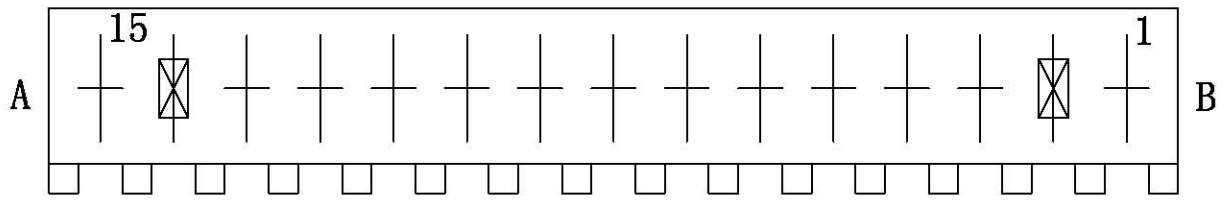

M7243-15-AB-0214-0-02H(2)

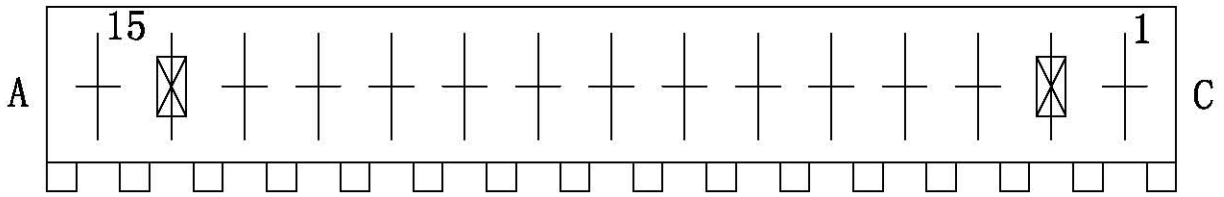

M7243-15-AC-0214-0-02H(2)

# 17 Circuits

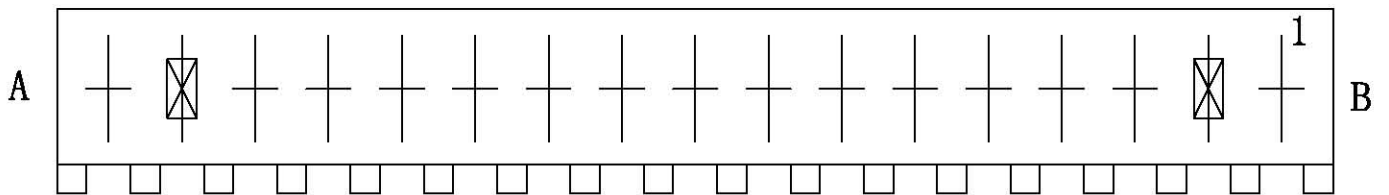

M7243R-17-AB-0216-0-02H(2)